

China Professional Manufacturer Outdoor WPC wall panel



GREEN DESIGN INTERNATIONAL CONTRIBUTION AWARD

A white rectangular box containing two QR codes on the left, a world map in the center, and the text "Guangdong, China" pointing to the location of the manufacturer in China. Below the QR codes are the labels "WhatsApp online" and "Wechat online".

WhatsApp online Wechat online

Guangzhou woodedtech Co.,Ltd
Guangzhou Bestry Co.,Ltd



Newtech
Timber

Sumuchang.com
Ideal outdoor decking, wall panel

木帝特
WOODEDTECH

Bestrydeck.com
Best outdoor decking
Better outdoor living

NewTechLumber
China Outdoor WPC Lumber Factory

COMPANY PROFILE

We are a professional WPC (Wood-Plastic Composite) manufacturer specializing in high-quality outdoor decking, wall panels, pergolas, and fencing. With 30 advanced extrusion lines and 200+ molds in various series, we offer customizable colors, lengths, and shapes to meet diverse project needs.

Our factory supports OEM production, allowing tailored solutions based on your designs. Whether for residential gardens, commercial landscapes, or architectural projects, our durable, eco-friendly, and low-maintenance WPC products ensure superior performance and aesthetic appeal.

Choose us for reliable quality, competitive pricing, and flexible customization—your trusted partner in outdoor WPC solutions!

●Location:Guangdong,China.

●Introduction:China best manufacture of all kinds of Outdoor WPC decking,Outdoor WPC wall panel,Outdoor WPC tubes,Outdoor WPC railing,Outdoor WPC Aluminium fence,Outdoor WPC tiles,Outdoor WPC Pergola,Outdoor WPC Gazebo,Outdoor WPC Customized drawings products

●Factory Area:25000 square meters ●Founded:in 2000

●Number of Employees:150 ●OEM&ODM Customization:Accepted

●Certification:CE,SGS,ISO



SERVICE



Pre -sale

Explore product technology and design solutions with customers



In -sale

Strictly follow the requirements of customer orders to control the quality of factory products, as well as the construction guidance and technical support of the product implementation project on site.



After -sale

Product problems caused by various reasons for products will be quickly replaced and maintained.





PRODUCT COLOR CARD

CO-EXTRUSION COLORS



Teak



Antique



Redwood



IPE



Light-grey



Walnut

CLASSIC COLORS



Teak



Redwood



Walnut



Coffee



Chocolate



Ebony

If the above colors do not meet your requirements,
We can adjust the colors according to the color
samples as provided.

CAPPED SLATTED COMPOSITE CLADDING



Upgrade your space with our innovative capped composite wall cladding. This advanced material features a tough plastic shield that completely encases a WPC core, offering unmatched protection against harsh weather, stains, and fading. Experience the timeless beauty of wood, without the maintenance hassles – a simple washdown keeps it looking pristine for years to come.

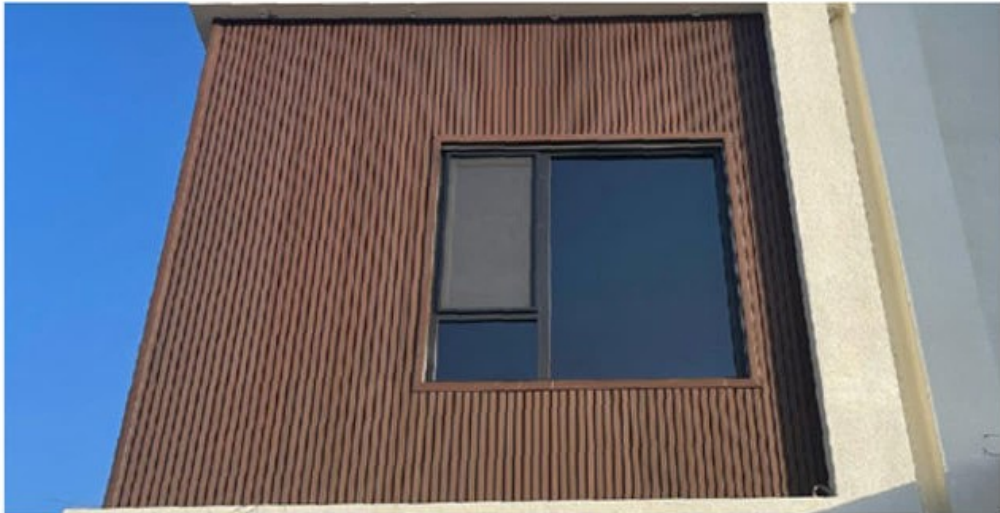



GQ22725:TK



GQ22725:AT



GQ22725:IP



GQ22725:RW



GQ22725:LG



GQ22725:WN



INSTALLATION GUIDE

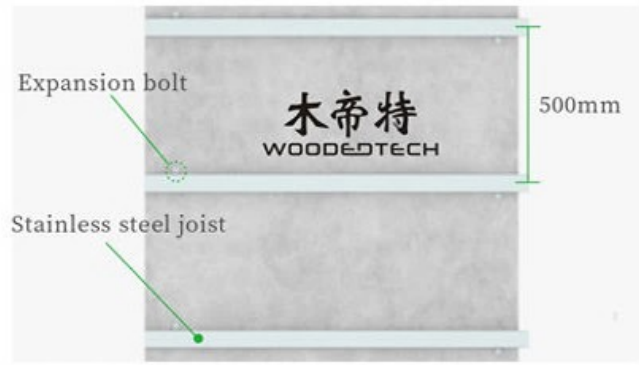

1. Install the joist, the center distance shall not exceed 500mm.



2. Fix the first cladding board to the joist with screw



3. Install other wall cladding in order



4. Install the L-Shaped Corner Trim with screws and complete the installation.

ACCESSORIES



Stainless Self Screw



Expansion Bolt



Expansion Screw



L-Shaped Corner Trim
Dim: 50*50*3000mm



WPC joist
Dim: 40*30*3000mm



Aluminum joist
Dim: 40*25*2900mm



Name: Capped Slatted Composite Cladding
Model: GQ22725
Color: Maple 6



Name: Capped Slatted Composite Cladding
Model: GQ22725
Color: Teak

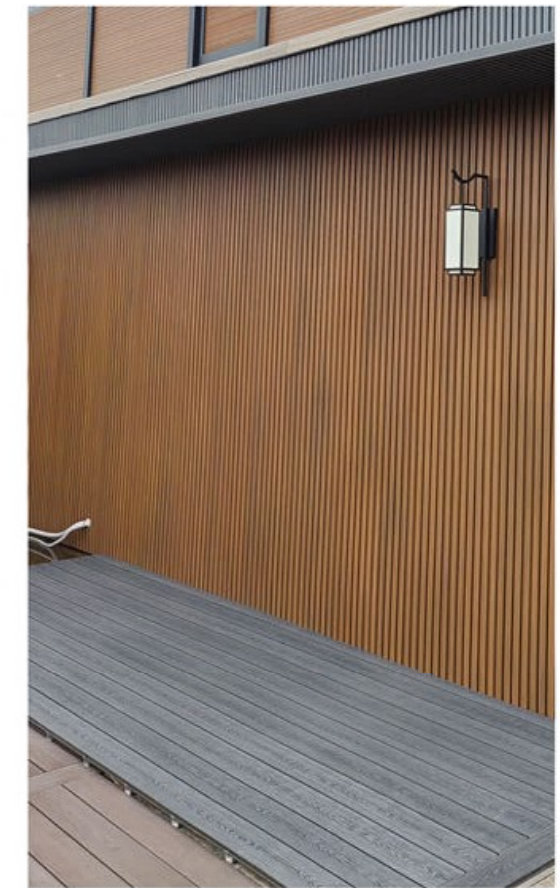
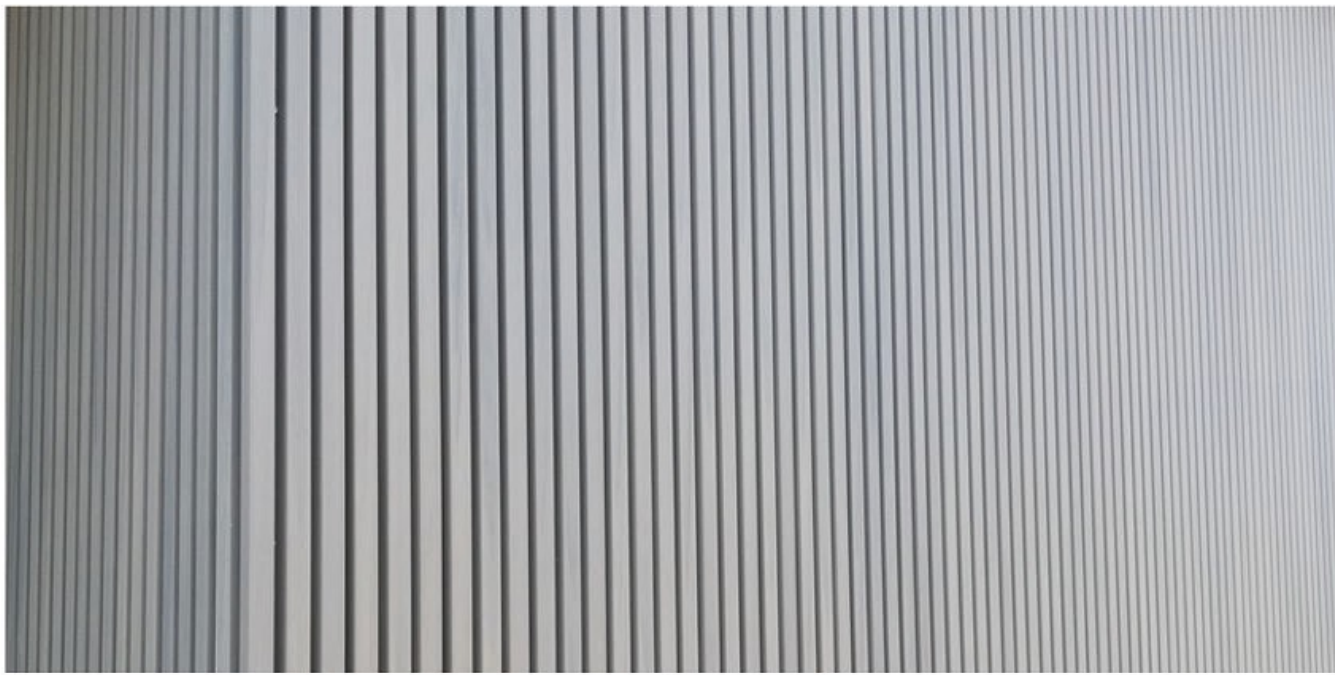

3D texture, rich colors, long-lasting durability without the need for painting or maintenance, suitable for a wide variety of outdoor locations.





The shape of the Great Wall has a more three-dimensional texture.

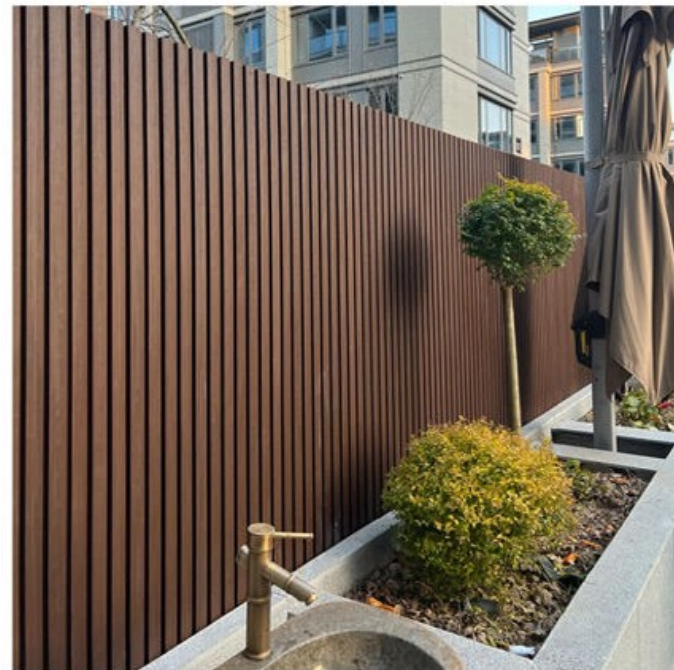
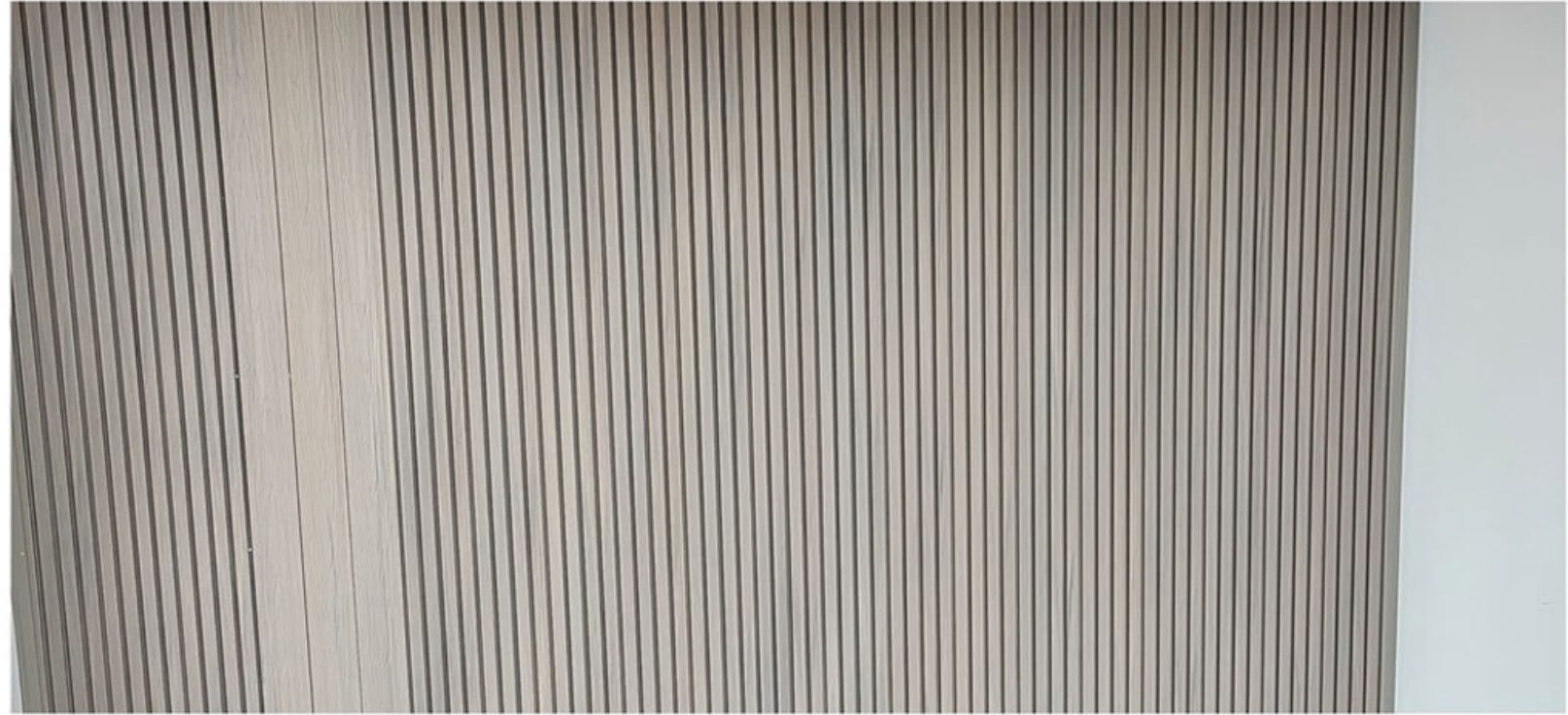

CAPPED COMPOSITE CLADDING



The WPC composite cladding boards can be installed either vertically or horizontally, easy installation and low maintenance, we use hidden system, the wall boards are overlap to hide the screw or clip. Nature timbers look but less timber problem, long-lasting and easy-going color.

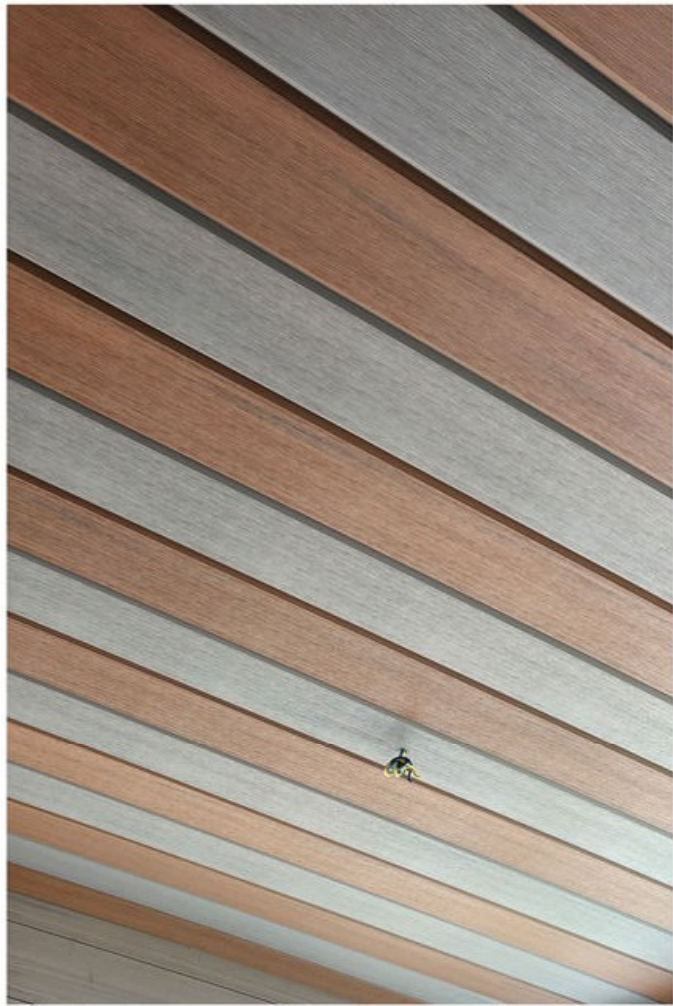

Capped WPC wall panel, co-extruded layer can resist harsh outdoor environments, high-quality effect, long-term maintenance-free



COMPOSITE CLADDING

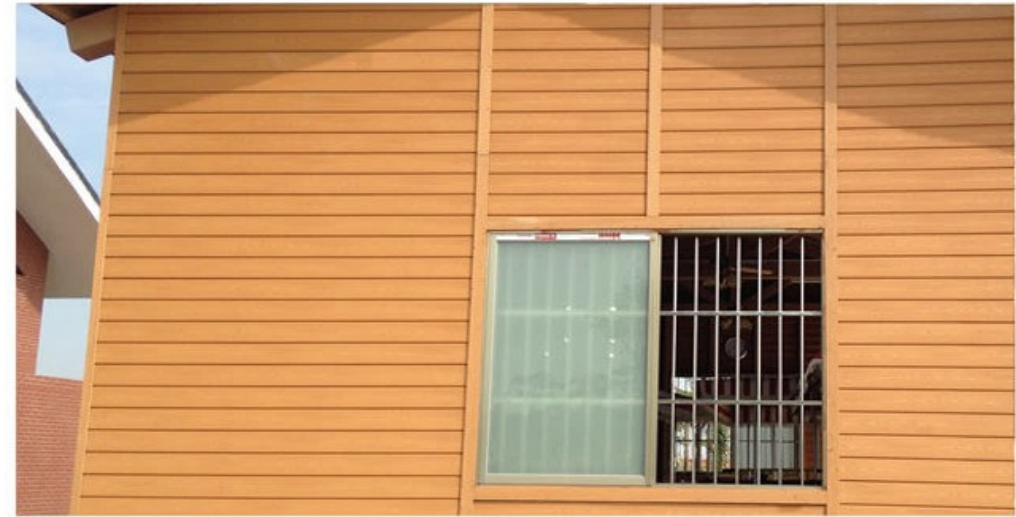
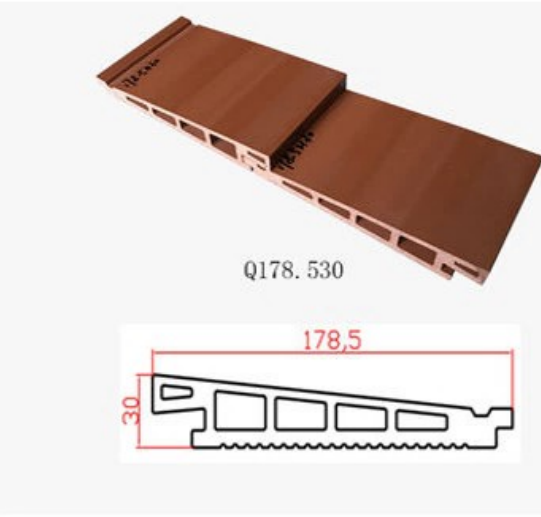

The WPC composite cladding boards can be installed either vertically or horizontally, easy installation and low maintenance, we use hidden system, the wall boards are overlap to hide the screw or clip. Nature timbers look but less timber problem, long-lasting and easy-going color.

INSTALLATION GUIDE

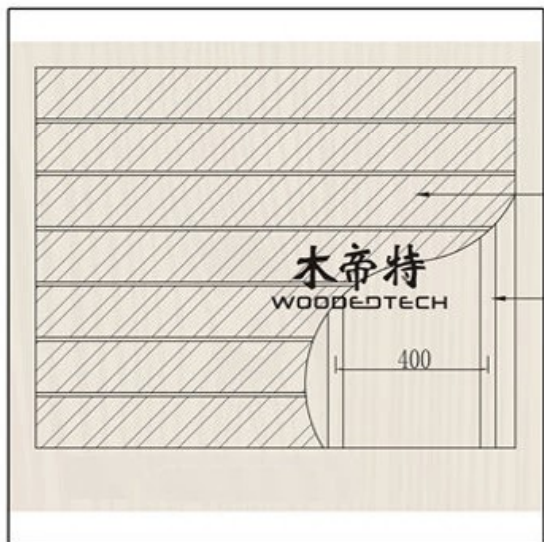
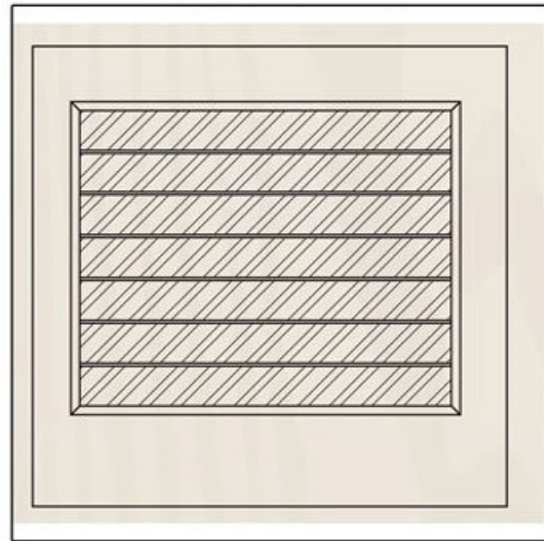
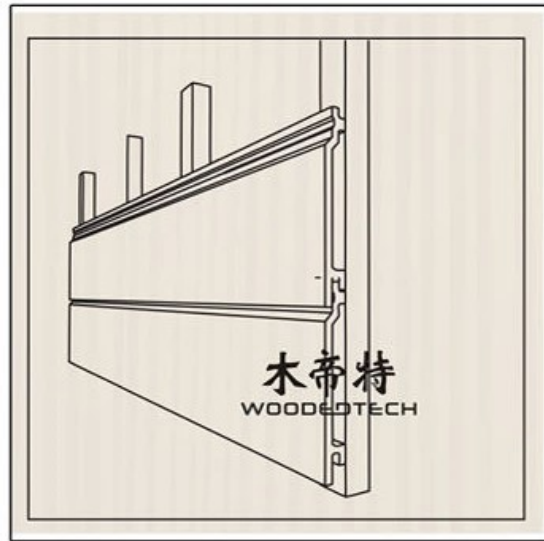
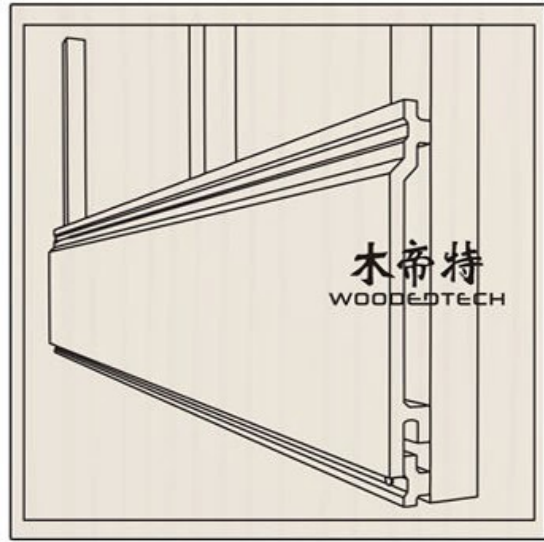
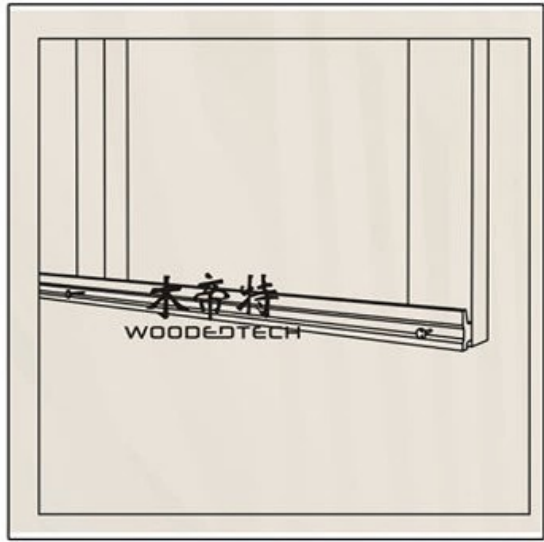



Classic WPC Wall panle of beautiful times in memory



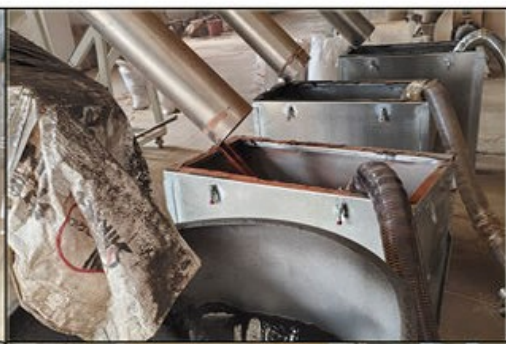

1,High-quality raw materials are mixed and granulated



2,Each model corresponds to at least one set of molds



3,The extruder extrudes the raw material into profiles using a mold



4,The extruded profiles must be neatly bundled and cooled.



Control the production quality of each process according to quality standards



5,Various surface treatments after cooling the extruded profiles



6,Precision cutting of WPC profiles according to requirements

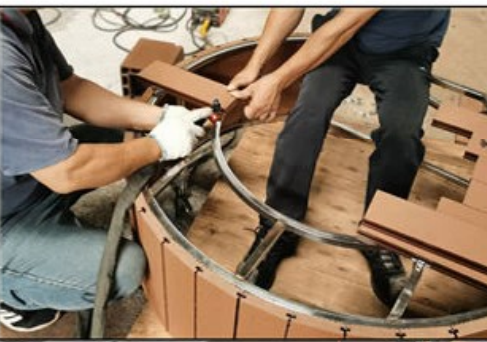

7,Perform woodworking tasks such as drilling, bending, and shaping.

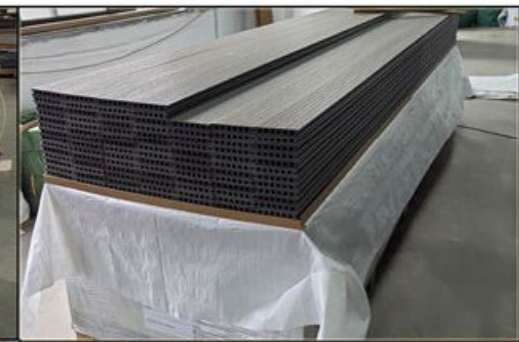

8,Packaged according to order requirements





Loading completed and waiting to arrive in your hands!



Email:woodedtech@gmail.com